

NPN D 系列晶体管/ D SERIES TRANSISTORS

BLD128DAT

- 特点: 耐压高 开关速度快 安全工作区宽 符合 RoHS 规范
- FEATURES: ■HIGH VOLTAGE CAPABILITY ■HIGH SPEED SWITCHING ■WIDE SOA ■RoHS COMPLIANT
- 应用: 节能灯 电子镇流器 电子变压器 开关电源
- APPLICATION: ■FLUORESCENT LAMP ■ELECTRONIC BALLAST ■ELECTRONIC TRANSFORMER
■SWITCH MODE POWER SUPPLY

- 最大额定值 (Tc=25°C)
- Absolute Maximum Ratings (Tc=25°C) TO-126/126S

参数 PARAMETER	符号 SYMBOL	额定值 VALUE	单位 UNIT
集电极-基极电压 Collector-Base Voltage	V _{CB0}	700	V
集电极-发射极电压 Collector-Emitter Voltage	V _{CEO}	400	V
发射极-基极电压 Emitter- Base Voltage	V _{EBO}	9	V
集电极电流 Collector Current	I _c	3.5	A
集电极耗散功率 Total Power Dissipation	P _{tot}	55	W
最高工作温度 Junction Temperature	T _j	150	°C
贮存温度 Storage Temperature	T _{stg}	-65-150	°C

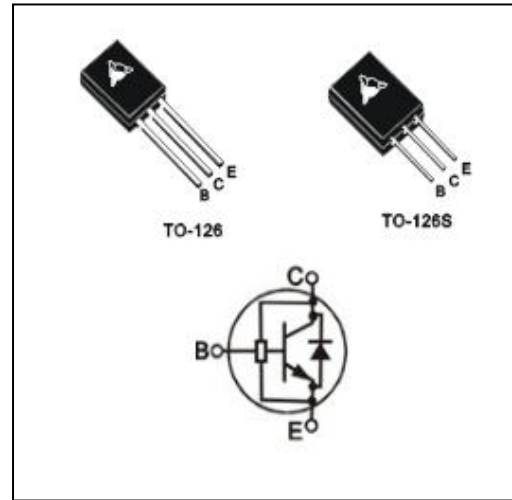

- 电特性 (Tc=25°C)
- Electronic Characteristics (Tc=25°C)

参数名称 CHARACTERISTICS	符号 SYMBOL	测试条件 TEST CONDITION	最小值 MIN	最大值 MAX	单位 UNIT
集电极-基极截止电流 Collector-Base Cutoff Current	I _{CBO}	V _{CB} =700V		100	μA
集电极-发射极截止电流 Collector-Emitter Cutoff Current	I _{CEO}	V _{CE} =400V, I _B =0		250	μA
集电极-基极电压 Collector-Base Voltage	V _{CB0}	I _c =1mA, I _E =0	700		V
集电极-发射极电压 Collector-Emitter Voltage	V _{CEO}	I _c =10mA, I _B =0	400		V
发射极-基极电压 Emitter- Base Voltage	V _{EBO}	I _E =1mA, I _C =0	9		V
集电极-发射极饱和电压 Collector-Emitter Saturation Voltage	V _{cesat}	I _c =1.0A, I _B =0.2A		0.5	V
		I _c =2A, I _B =0.5A		1.0	
发射极-基极饱和电压 Base-Emitter Saturation Voltage	V _{besat}	I _c =1.0A, I _B =0.2A		1.5	V
电流放大倍数 DC Current Gain	h _{FE}	V _{CE} =5V, I _c =10mA	7		
		V _{CE} =5V, I _c =1.0A	10	40	
		V _{CE} =5V, I _c =4A	5		
贮存时间/Storage Time	t _s	V _{CC} =5V, I _c =0.5A, (UI9600)	2.0	4.0	μs
下降时间/Falling Time	t _f			0.8	
内置二极管正向压降 Diode Forward Voltage	V _F	I _F =2A		1.7	V

●订单信息/ORDERING INFORMATION:

包装形式/PACKING	订货编码/ORDERING CODE			
	普通塑封料/ Normal Package		无卤塑封料/Halogen Free	
TO-126 普通袋装/NORMAL PACKING	BLD128DAT	TO-126	BLD128DAT	TO-126-HF
TO-126S 普通袋装/NORMAL PACKING	BLD128DAT	TO-126S	BLD128DAT	TO-126S-HF

NPN D 系列晶体管 / D SERIES TRANSISTORS

BLD128DAT

SOA (DC)

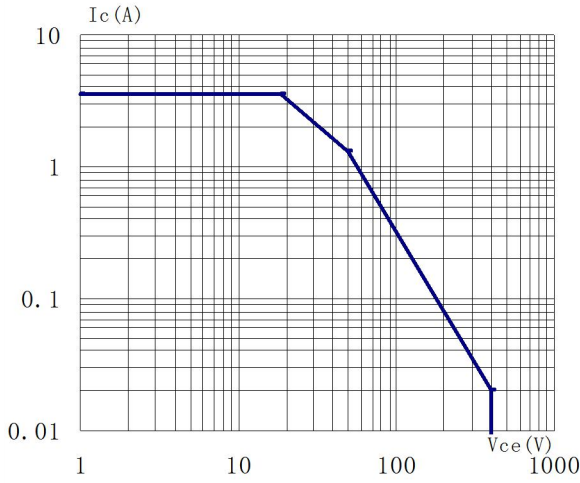

$P_{tot} \propto T_j$

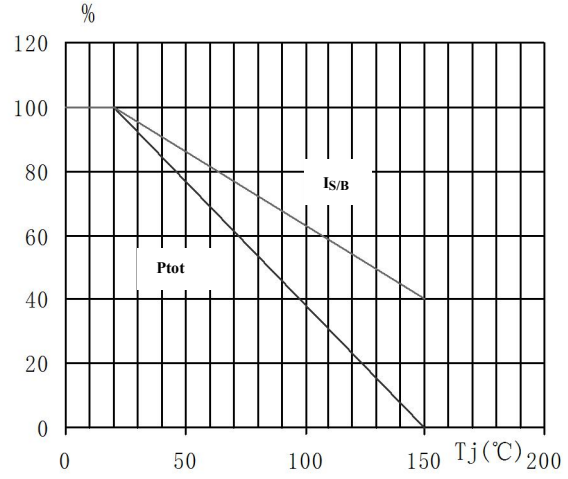

$h_{FE} - I_c$

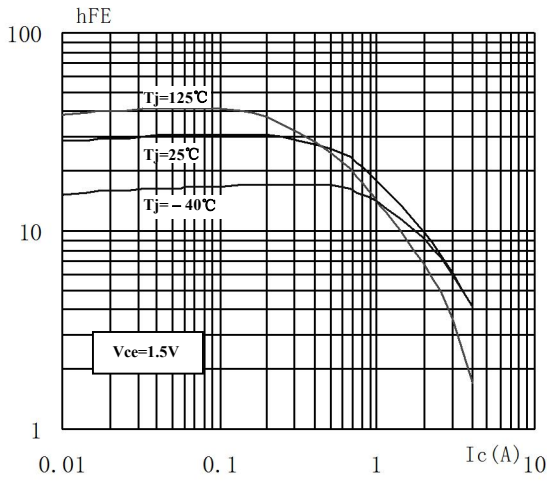

$h_{FE} - I_c$

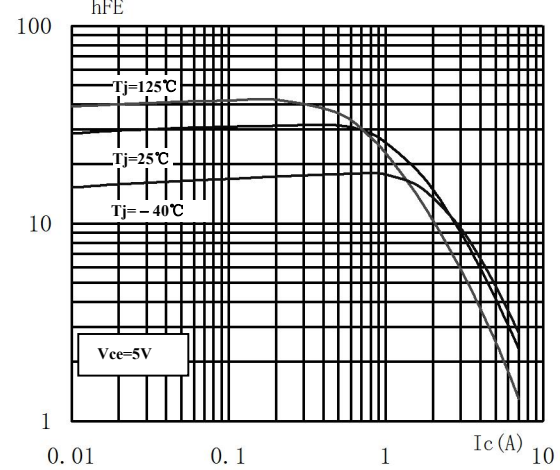

$V_{cesat} - I_c$

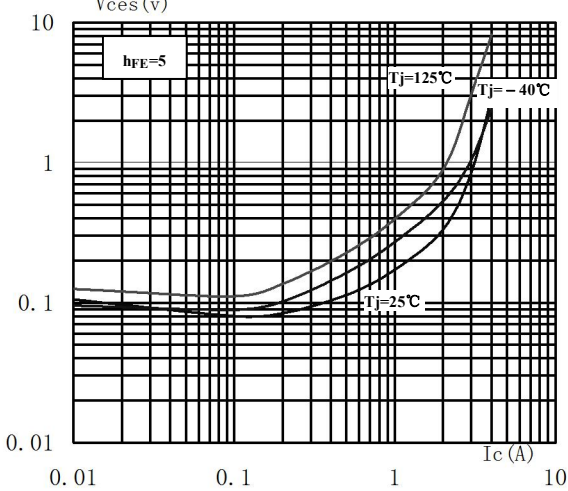

$V_{besat} - I_c$

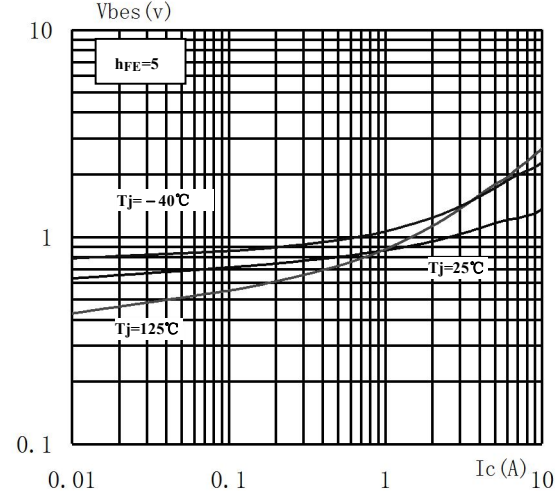

TO-126 封装机械尺寸 TO-126 MECHANICAL DATA

单位:毫米/UNIT: mm

符号 SYMBOL	最小值 min	典型值 nom	最大值 max	符号 SYMBOL	最小值 min	典型值 nom	最大值 max
A	2.30		2.80	L	15.00		16.50
B	1.15		1.42	L1	1.50		2.54
b	0.65		0.90	ϕP	2.90		3.60
c	0.35		0.65	$\phi P1$		5.00	
D	10.50		11.10	Q	3.60		4.40
E	7.20		7.80	Q1	0.90		1.50
e		2.29		R		0.50	

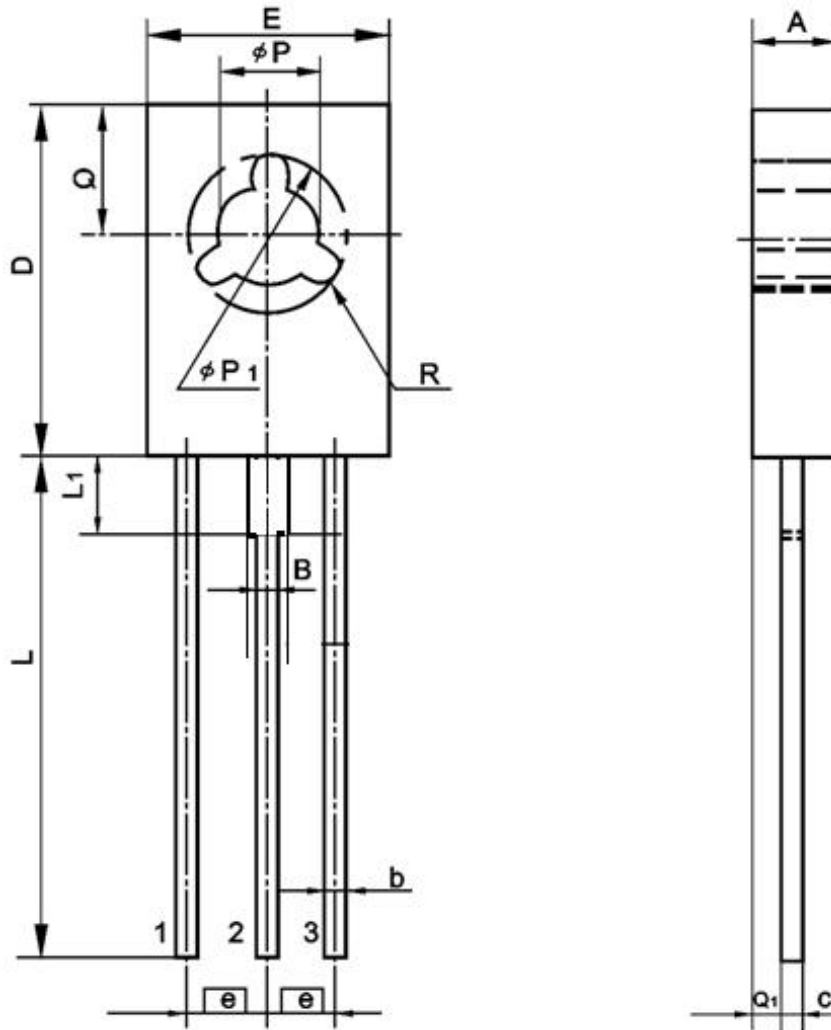

TO-126S 封装机械尺寸 TO-126S MECHANICAL DATA

单位:毫米/UNIT: mm

符号 SYMBOL	最小值 min	典型值 nom	最大值 max	符号 SYMBOL	最小值 min	典型值 nom	最大值 max
A	2.30		2.80	L	3.20		3.80
B	1.15		1.42	L1	1.50		2.54
b	0.65		0.90	ϕP	2.90		3.60
c	0.35		0.65	$\phi P1$		5.00	
D	10.50		11.10	Q	3.60		4.40
E	7.20		7.80	Q1	0.90		1.50
e		2.29		R		0.50	

