

肖特基二极管/Power Schottky Rectifier

MBR3060CCT

- 特点: 抗高浪性能 高功效 低正向电压 大电流 低功耗 符合 RoHS 规范
- FEATURES: ■HIGH SURGE CAPABILITY ■HIGH EFFICIENCY ■LOW FORWARD VOLTAGE
■HIGH CURRENT CAPABILITY ■LOW POWER LOSS ■RoHS COMPLIANT
- 应用: 低压高频逆变电路 续流电流 保护电流
- APPLICATION: ■LOW VOLTAGE,HIGH FREQUENCY INVERTERS ■FREE WHEELING
■POLARITY PROTECTION APPLICATIONS

●最大额定值 (Tc=25°C)

●Absolute Maximum Ratings (Tc=25°C) TO-220/220FP/263

参数 PARAMETER	符号 SYMBOL	额定值 VALUE	单位 UNIT
反向重复峰值电压 Repetitive Peak Reverse Voltage	V _{RRM}	60	V
最大直流阻断电压 Maximum DC Reverse Voltage	V _R	60	V
平均整流输出电流 Average Rectified Output Current @Tc=125°C	I _{F(AV)}	30	A
正向峰值浪涌电流 Peak Forward Surge Current 8.3ms Single half sine-wave superimposed on rated load (JEDEC Method)	I _{FSM}	300	A
最高结温 Maximum Operating Junction Temperature	T _J	150	°C
贮存温度 Storage Temperature	T _{stg}	-50-150	°C

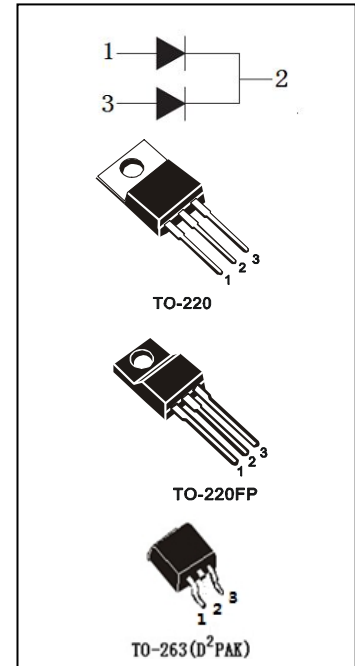

●电特性 (Tc=25°C) Electronic Characteristics (Tc=25°C)

参数名称 CHARACTERISTICS	符号 SYMBOL	测试条件 TEST CONDITION	最小值 MIN	典型值 TYP	最大值 MAX	单位 UNIT
正向压降 Forward Voltage Drop	V _{FM}	@I _F =15A, Tc=25°C			0.78	V
		@I _F =15A, Tc=125°C			0.73	
		@I _F =20A, Tc=25°C			0.92	
		@I _F =20A, Tc=125°C			0.87	
反向电流 Peak Reverse Current @ Rated V _R	I _{RM}	@Tc=25°C			0.05	mA
		@Tc=125°C			50	

●热特性 Thermal Characteristics

项目 PARAMETER	符号 SYMBOL	最大值 VALUE	单位 UNIT
热阻结-壳 Thermal Resistance Junction-case	R _{thJC}	TO-220: 1.2	°C/W
		TO-220FP: 3.4	
		TO-263: 1.2	

●订单信息/ORDERING INFORMATION:

包装形式/PACKING	订货编码/ORDERING CODE	
	普通塑封料/ Normal Package Material	无卤塑封料/Halogen Free
TO-220 条管装/TUBE PACKING	MBR3060CCT TO-220-TU	MBR3060CCT TO-220-TU-HF
TO-220FP 条管装/TUBE PACKING	MBR3060CCT TO-220FP-TU	MBR3060CCT TO-220FP-TU-HF
TO-263 条管装/TUBE PACKING	MBR3060CCT TO-263-TU	MBR3060CCT TO-263-TU-HF

肖特基二极管/Power Schottky Rectifier

MBR3060CCT

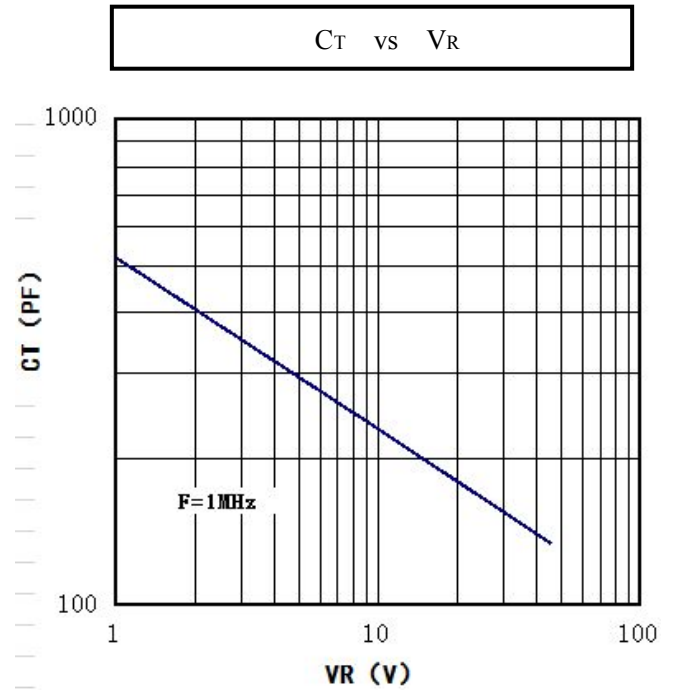
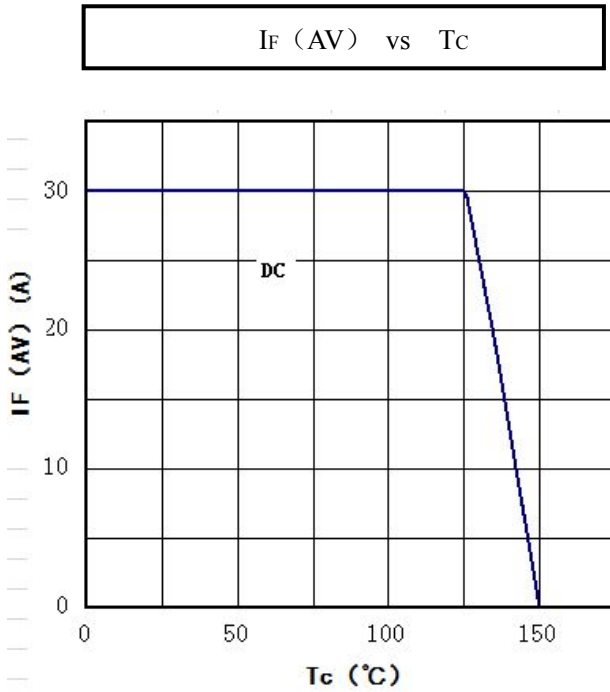
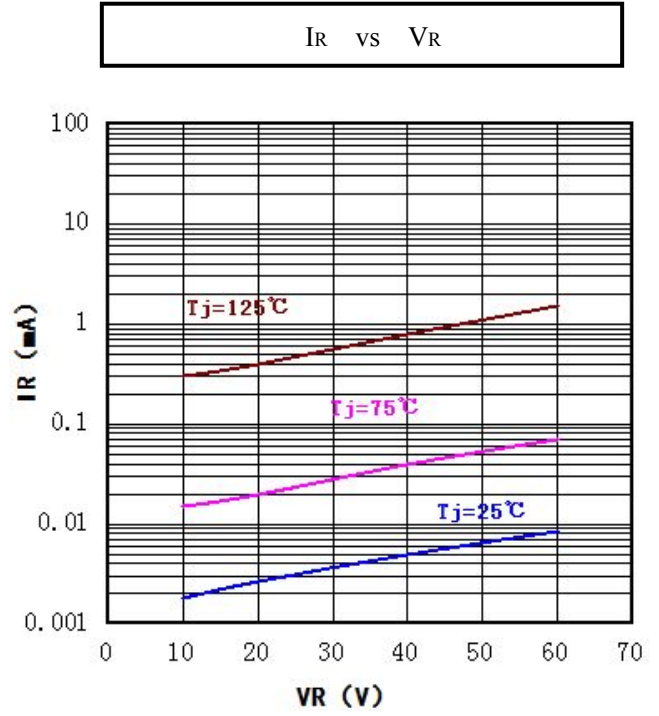
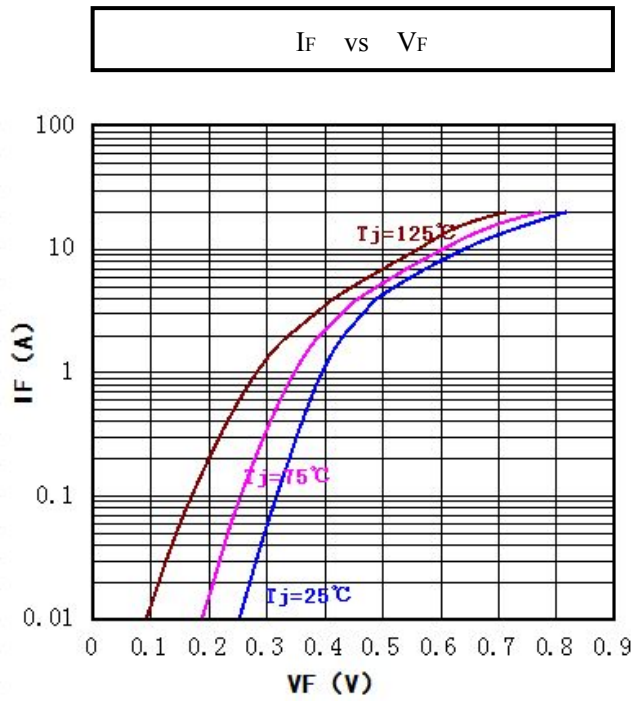

TO-220 封装机械尺寸 TO-220 MECHANICAL DATA

单位：毫米/UNIT: mm

符号 SYMBOL	最小值 min	典型值 nom	最大值 max	符号 SYMBOL	最小值 min	典型值 nom	最大值 max
A	4.00		4.80	E	9.90		10.70
B	1.20		1.50	e		2.54	
B1	1.00		1.40	F	1.10		1.45
b1	0.65		1.00	L	12.50		14.50
c	0.35		0.75	L1	3.00	3.50	4.00
D	15.00		16.50	Q	2.50		3.00
D1	5.90		6.90	Q1	2.00		3.00
				ϕP	3.60		3.90

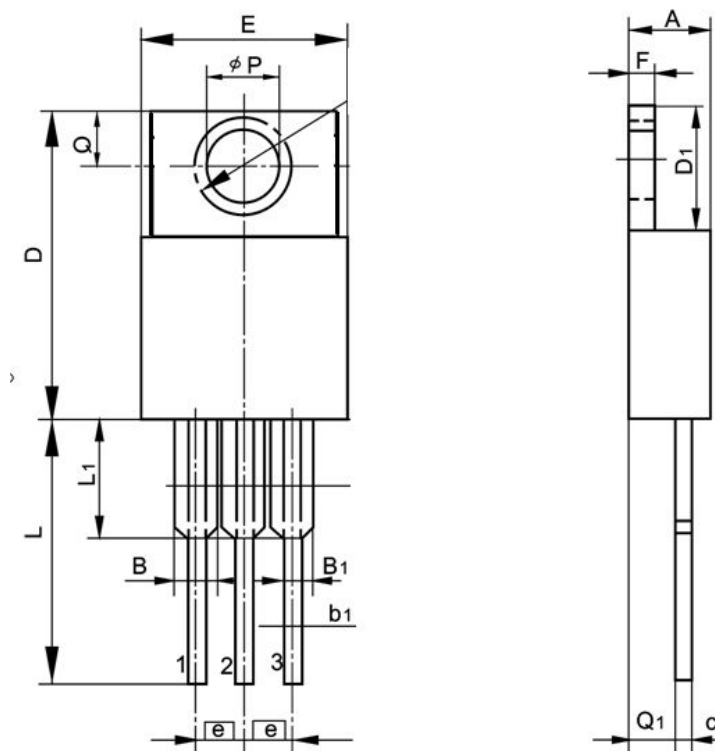

TO-220FP 封装机械尺寸 TO-220FP MECHANICAL DATA

单位:毫米/UNIT: mm

符号 SYMBOL	最小值 min	典型值 nom	最大值 max	符号 SYMBOL	最小值 min	典型值 nom	最大值 max
A	4.20		4.75	e		2.54	
A ₁	2.30		2.90	L	12.50		14.30
b	0.45		0.90	L ₁	9.10		10.05
b ₁	1.10		1.70	L ₂	15.00		16.00
c	0.35		0.90	L ₃	3.00		4.00
D	14.50		17.00	øp	3.00		3.50
D ₁	6.10		9.00	Q	2.30		2.80
E	9.60		10.30				

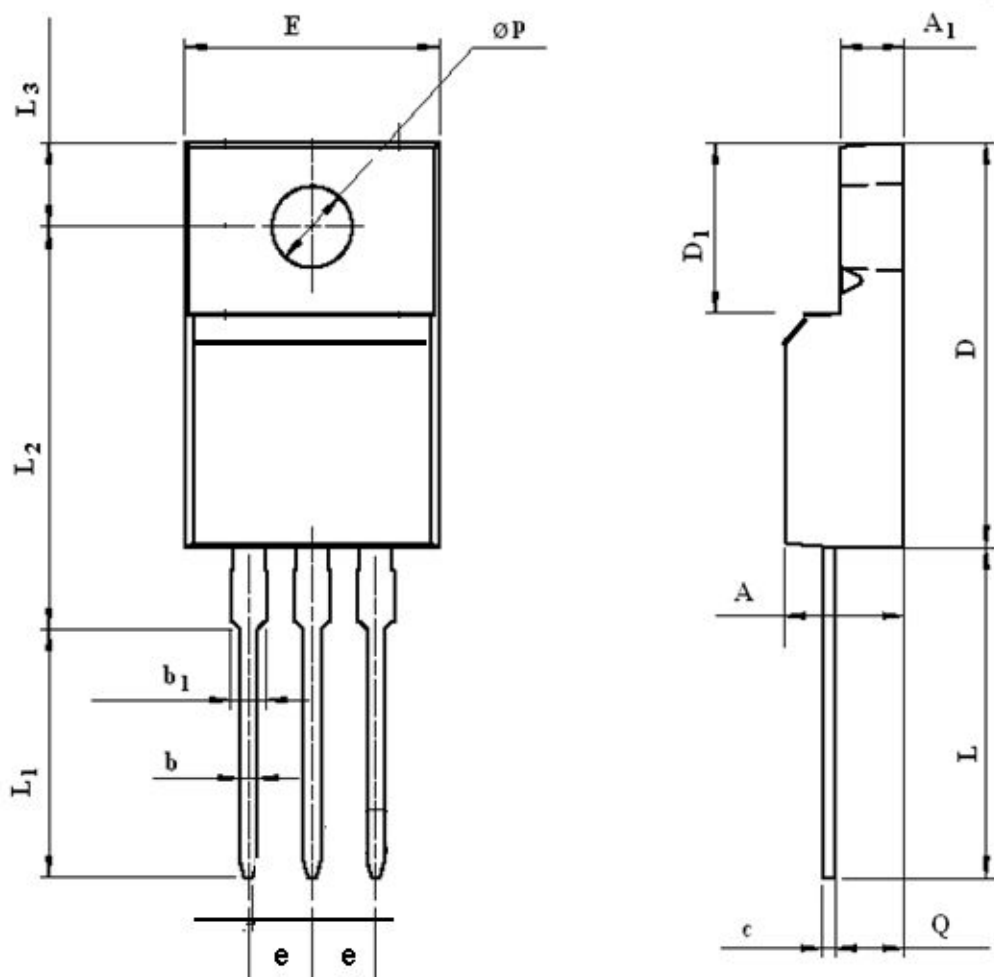

TO-263 封装机械尺寸 TO-263(D2PAK) MECHANICAL DATA

单位：毫米/UNIT: mm

符号 SYMBOL	最小值 min	典型值 nom	最大值 max	符号 SYMBOL	最小值 min	典型值 nom	最大值 max
A	4.42		4.72	E	8.99		9.29
B	1.22		1.32	e1	2.44		2.64
b	0.76		0.86	e2	4.98		5.18
b1	1.22		1.32	L1	15.19		15.79
b2	0.33		0.43	L2	2.29		2.79
C	1.22		1.32	L3	1.30		1.75
D	9.95		10.25				

