

NPN MJE 系列晶体管/MJE SERIES TRANSISTORS

MJE13009A

- 特点：耐高压 开关速度快 安全工作区宽 符合 RoHS 规范
- FEATURES: ■HIGH VOLTAGE CAPABILITY ■HIGH SPEED SWITCHING ■WIDE SOA ■RoHS COMPLIANT
- 应用：节能灯 电子镇流器 电子变压器 开关电源
- APPLICATION: ■FLUORESCENT LAMP ■ELECTRONIC BALLAST ■ELECTRONIC TRANSFORMER
■ SWITCH MODE POWER SUPPLY

●最大额定值 (Tc=25°C)

●Absolute Maximum Ratings (Tc=25°C) **TO-3P**

参数 PARAMETER	符号 SYMBOL	额定值 VALUE	单位 UNIT
集电极-基极电压 Collector-Base Voltage	V _{CB0}	700	V
集电极-发射极电压 Collector-Emitter Voltage	V _{CEO}	400	V
发射极-基极电压 Emitter- Base Voltage	V _{EBO}	12	V
集电极电流 Collector Current	I _c	12	A
集电极耗散功率 Total Power Dissipation	P _{tot}	130	W
最高工作温度 Junction Temperature	T _j	150	°C
贮存温度 Storage Temperature	T _{stg}	-65-150	°C

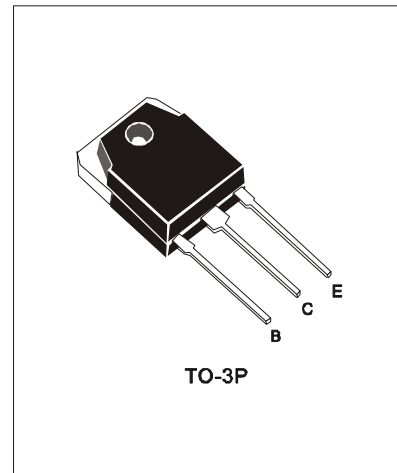

●电特性 (Tc=25°C)

●Electronic Characteristics (Tc=25°C)

参数名称 CHARACTERISTICS	符号 SYMBOL	测试条件 TEST CONDITION	最小值 MIN	最大值 MAX	单位 UNIT
集电极-基极截止电流 Collector-Base Cutoff Current	I _{CB0}	V _{CB} =700V		100	μA
集电极-发射极截止电流 Collector-Emitter Cutoff Current	I _{CEO}	V _{CE} =400V, I _B =0		250	μA
集电极-基极电压 Collector-Base Voltage	V _{CB0}	I _c =1mA, I _E =0	700		V
集电极-发射极电压 Collector-Emitter Voltage	V _{CEO}	I _c =10mA, I _B =0	400		V
发射极-基极电压 Emitter- Base Voltage	V _{EBO}	I _E =1mA, I _c =0	12		V
集电极-发射极饱和电压 Collector-Emitter Saturation Voltage	V _{cesat}	I _c =8.0A, I _B =1.6A		0.8	V
		I _c =12A, I _B =3.0A		1.8	
发射极-基极饱和电压 Base-Emitter Saturation Voltage	V _{besat}	I _c =8A, I _B =1.6A		1.5	V
电流放大倍数 DC Current Gain	h _{FE}	V _{CE} =5V, I _c =10mA	7		
		V _{CE} =5V, I _c =3A	10	40	
		V _{CE} =5V, I _c =12A	5		
贮存时间 Storage Time	t _s	V _{CC} =5V, I _c =0.5A (UI9600)	5.0	9.0	μs
下降时间 Falling Time	t _f			0.15	

●订单信息/ORDERING INFORMATION:

包装形式/PACKING	订货编码/ORDERING CODE	
	普通塑封料/ Normal Package Material	无卤塑封料/Halogen Free
TO-3P 条管装/TUBE PACKING	MJE13009A TO-3P-TU	MJE13009A TO-3P-TU-HF

NPN MJE 系列晶体管/MJE SERIES TRANSISTORS

MJE13009A

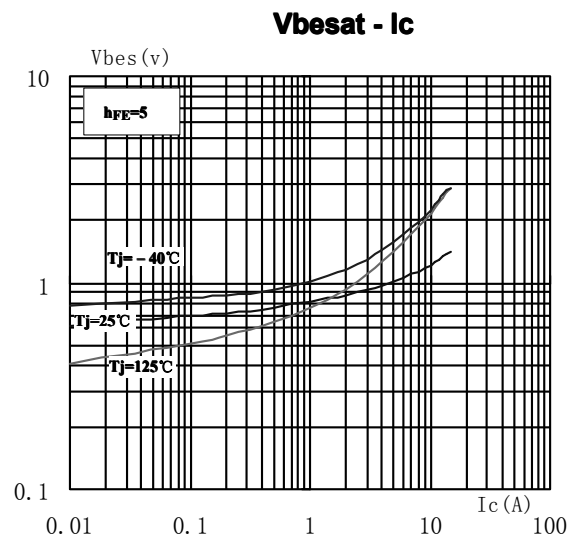
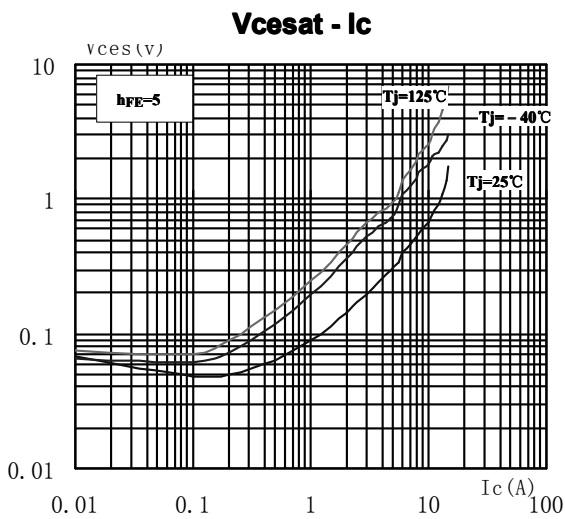
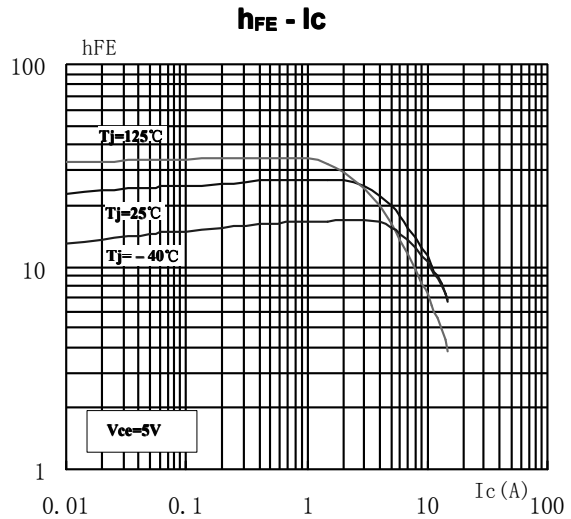
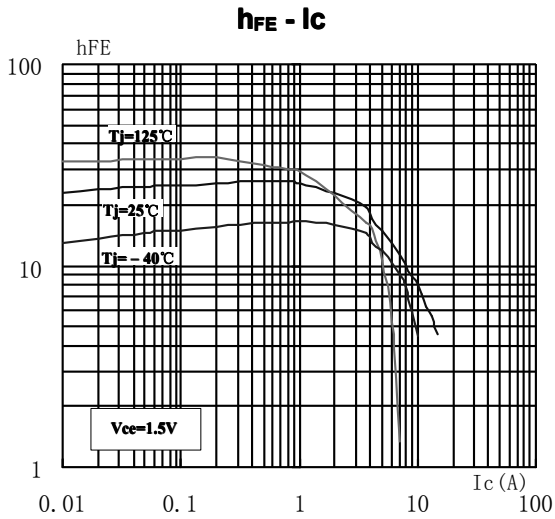
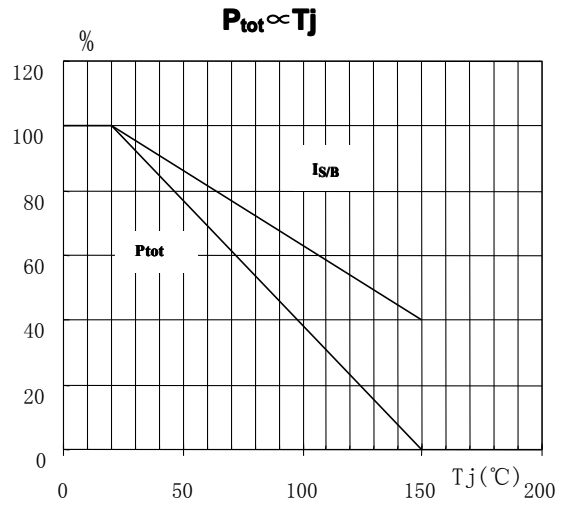
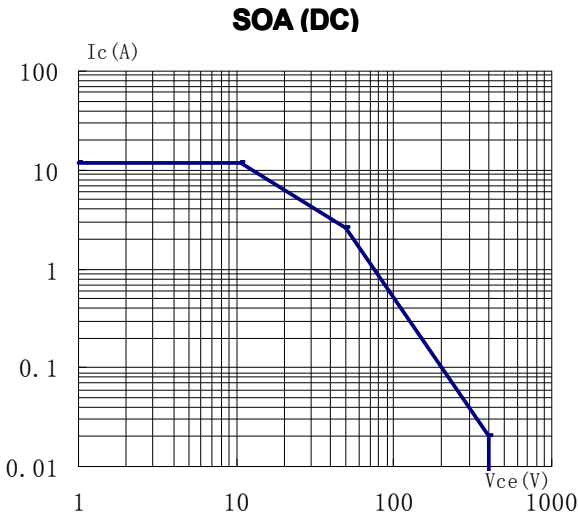

TO-3P 封装机械尺寸 TO-3P MECHANICAL DATA

单位：毫米/UNIT: mm

符号 SYMBOL	最小值 min	典型值 nom	最大值 max	符号 SYMBOL	最小值 min	典型值 nom	最大值 max
A	4.50		5.00	E	15.40		15.80
A1	1.45	1.50	1.65	E1		13.60	
A2	1.20	1.40	1.60	E2		9.60	
b	0.80	1.00	1.20	e	5.15	5.45	5.75
b1	1.80		2.20	L	19.50	20	20.50
b2	2.80		3.20	L1	2.90	3.50	
C	0.55	0.60	0.75	P	3.10	3.30	3.50
D	19.70	19.90	20.10	Q		5.00	
D1		13.90		Q1		3.80	

