

N-沟道功率 MOS 管/ N-CHANNEL POWER MOSFET

SIF115N080

- 特点: 热阻低 导通电阻低 栅极电荷低, 开关速度快 输入阻抗高 符合RoHS规范
- FEATURES: ■LOW THERMAL RESISTANCE ■LOW $R_{DS(ON)}$ TO MINIMIZE CONDUCTIVE LOSS ■LOW GATE CHARGE FOR FAST SWITCHING ■HIGH INPUT RESISTANCE ■RoHS COMPLIANT
- 应用: 低压高频逆变电路 同步整流 开关
- APPLICATION: ■LOW VOLTAGE,HIGH FREQUENCY INVERTERS ■SYNCHRONOUS RECTIFIER ■PRIMARY SWITCH

●最大额定值 (TC=25°C)

●Absolute Maximum Ratings (Tc=25°C) TO-220/220FP

参数 PARAMETER	符号 SYMBOL	额定值 VALUE	单位 UNIT
漏-源电压 Drain-source Voltage	V_{DS}	80	V
栅-源电压 gate-source Voltage	V_{GS}	± 20	V
漏极电流 Continuous Drain Current TC=25°C ①	I_D	115	A
耗散功率 Total Power Dissipation ①	P_{tot}	220:200 FP:40	W
最高结温 Junction Temperature	T_j	150	°C
存储温度 Storage Temperature	T_{STG}	-55-175	°C
单脉冲雪崩能量 Single Pulse Avalanche Energy ②	E_{AS}	600	mJ

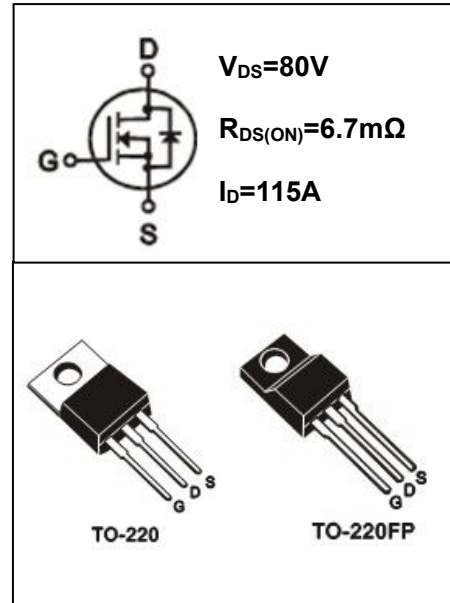

●电特性 (Tc=25°C)

●Electronic Characteristics (Tc=25°C)

参数 PARAMETER	符号 SYMBOL	测试条件 TEST CONDITION	最小值 MIN	典型值 TYP	最大值 MAX	单位 UNIT
漏-源击穿电压 Drain-source Breakdown Voltage	BV_{DSS}	$V_{GS}=0V, I_D=250\mu A$	80	85		V
栅极开启电压 Gate Threshold Voltage	$V_{GS(TH)}$	$V_{GS}=V_{DS}, I_D=250\mu A$	1.4		2.5	V
漏-源漏电流 Drain-source Leakage Current	I_{DSS}	$V_{DS}=80V, V_{GS}=0V,$			1	μA
栅极漏电流 Gate-body Leakage Current	I_{GSS}	$V_{GS}=\pm 20V, V_{DS}=0V$			±100	nA
漏-源导通电阻 Static Drain-source On Resistance	$R_{DS(ON)}$	$V_{GS}=4.5V, I_D=20A$		7.8	9	mΩ
		$V_{GS}=10V, I_D=20A$		6.7	8	
跨导 Forward Transconductance	g_{FS}	$V_{DS}=50V, I_D=20A$		33		S

●订单信息/ORDERING INFORMATION:

包装形式/PACKING	订货编码/ORDERING CODE	
	普通塑封料 Normal Package Material	无卤塑封料 Halogen Free
TO-220(FP) 条管装/TUBE PACKING	SIF115N080 TO-220(FP)-TU	SIF115N080 TO-220(FP)-TU-HF

N-沟道功率 MOS 管/ N-CHANNEL POWER MOSFET

SIF115N080

参数 PARAMETER	符号 SYMBOL	测试条件 TEST CONDITION	最小值 MIN	典型值 TYP	最大值 MAX	单位 UNIT
输入电容 Input Capacitance	Ciss	$V_{GS} = 0V, V_{DS} = 20V$ $F = 1.0MHz$		2940		pF
输出电容 Output Capacitance	Coss			410		
反向传输电容 Reverse Transfer Capacitance	Crss			267		
栅极电荷 Total Gate Charge	Qg	$I_D = 40A, V_{DS} = 20V$ $V_{GS} = 10V$		82		nC
栅源电荷 Gate-to-Source Charge	Qgs			17		nC
栅漏电荷 Gate-to-Drain Charge	Qgd			28		nC
导通延迟 Turn -On Delay Time	Td(on)	$V_{DD} = 20V, I_D = 20A$ $V_{GS} = 10V, R_{GEN} = 2.5\Omega$		15		ns
开启上升时间 Turn -On Rise Time	T _r			50		ns
关断延迟 Turn -Off Delay Time	Td(off)			40		ns
关断下降时间 Turn -Off Fall Time	T _f			55		ns
二极管正向压降 Diode Forward Voltage	V _{SD}	$T_j = 25^\circ C, I_F = 20A$ $V_{GS} = 0V$ ③			1.2	V
反向恢复时间 Reverse Recovery Time	t _{rr}	$I_f = 40A, di/dt = 100A/\mu s$ $T_j = 25^\circ C, \text{③}$		38	80	ns
反向恢复电荷 Reverse Recovery Charge	Q _{rr}			53	100	nC

●热特性

● Thermal Characteristics

参数 PARAMETER	符号 SYMBOL	最大值 MAX		单位 UNIT
		TO-220	TO-220FP	
热阻结-壳 Thermal Resistance Junction-case	RthJC	0.89	3.13	°C/W
热阻结-环境 Thermal Resistance Junction-ambient	RthJA	62.5	62.5	°C/W

注释(Notes):

- ① 以最高结温为限制， T_c=25°C时测试。
I_D & P_D base on maximum allowable junction temperature, test at T_c=25°C.
- ② 初始结温=25°C, L=1mH.
Starting T_j=25°C, L=1mH
- ③ 脉冲测试: 脉冲宽度≤ 300μs , 占空比≤ 2%
Pulse Test : Pulse width ≤ 300μs, Duty cycle ≤ 2%

N-沟道功率 MOS 管/ N-CHANNEL POWER MOSFET

SIF115N080

● 特性曲线

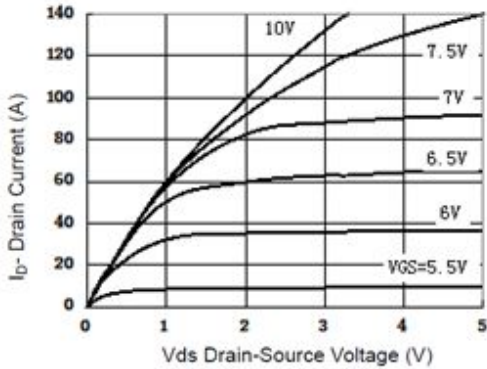

Figure 1 Output Characteristics

图 1 输出特性曲线, $T_c=25^\circ\text{C}$

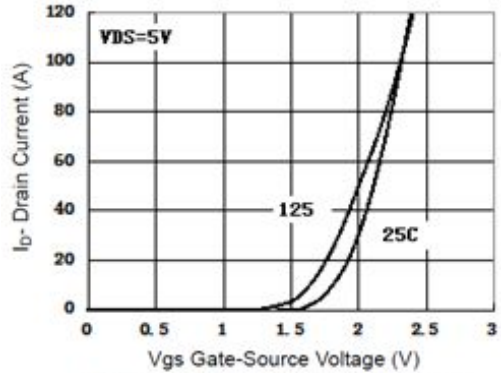

Figure 2 Transfer Characteristics

图 2 转移特性曲线

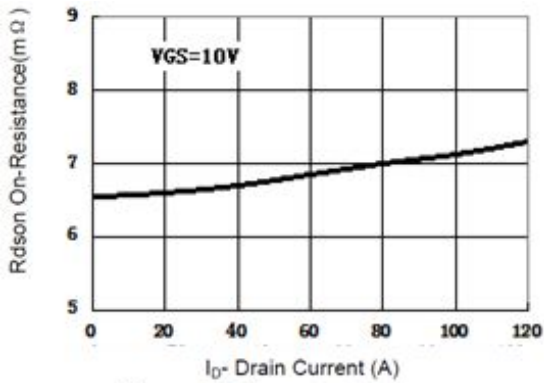

Figure 3 $R_{DS(on)}$ - Drain Current

图 3 导通电阻与漏极电流 曲线

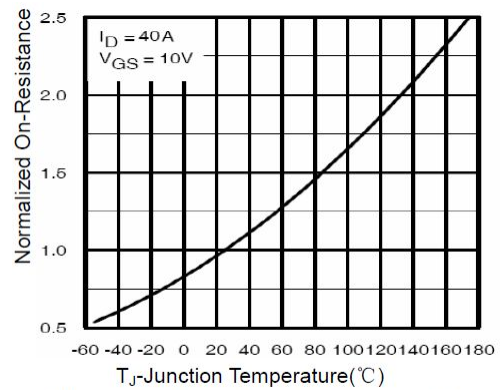

Figure 4 $R_{DS(on)}$ -Junction Temperature

图 4 导通电阻与结温度 曲线

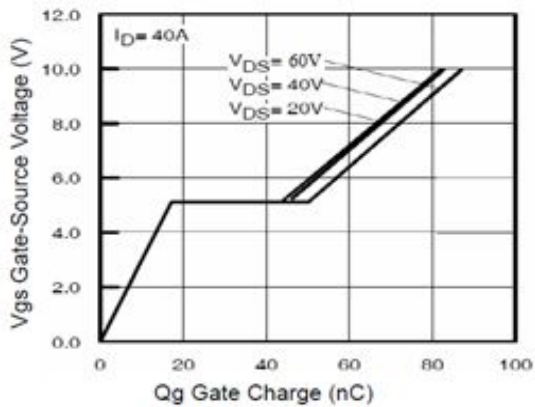

Figure 5 Gate Charge

图 5 栅电荷 曲线

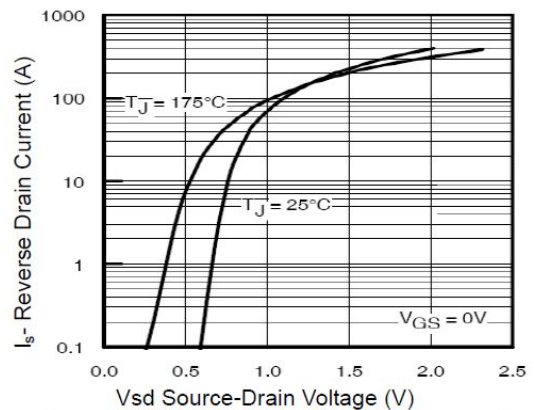

Figure 6 Source- Drain Diode Forward

图 6.二极管正向压降与源极电流 曲线

N-沟道功率 MOS 管/ N-CHANNEL POWER MOSFET

SIF115N080

● 特性曲线

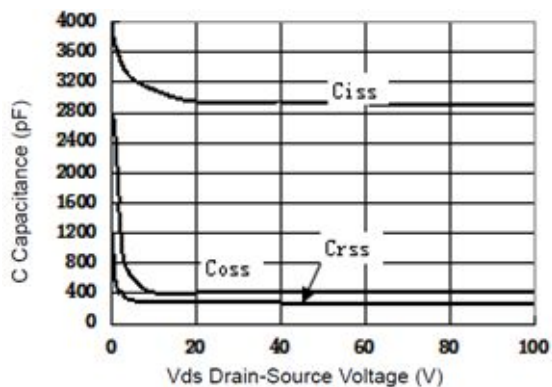

Figure 7 Capacitance vs Vds

图 7 电容特性曲线

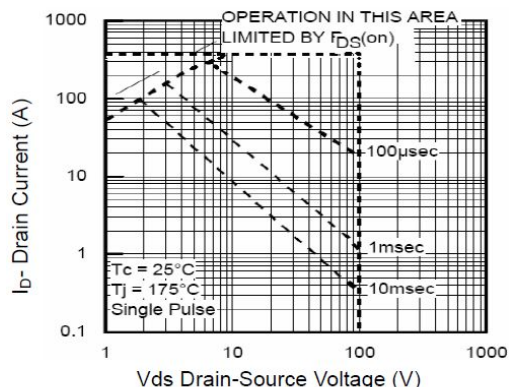

Figure 8 Safe Operation Area

图 8 SOA 曲线

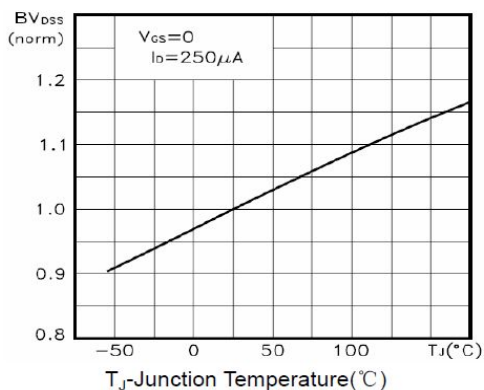

Figure 9 BV_{DSS} vs Junction Temperature

图 9 BV_{DSS} -结温曲线

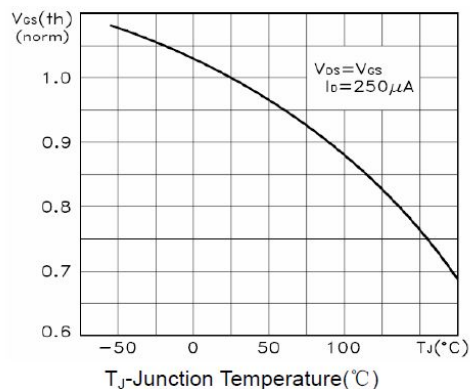

Figure 10 $V_{GS(th)}$ vs Junction Temperature

图 10 $V_{GS(th)}$ -结温曲线

TO-220 封装机械尺寸 TO-220 MECHANICAL DATA

单位：毫米/UNIT: mm

符号 SYMBOL	最小值 min	典型值 nom	最大值 max	符号 SYMBOL	最小值 min	典型值 nom	最大值 max
A	4.00		4.80	E	9.90		10.70
B	1.20		1.50	e		2.54	
B1	1.00		1.40	F	1.10		1.45
b1	0.65		1.00	L	12.50		14.50
c	0.35		0.75	L1	3.00	3.50	4.00
D	15.00		16.50	Q	2.50		3.00
D1	5.90		6.90	Q1	2.00		3.00
				φ P	3.60		3.90

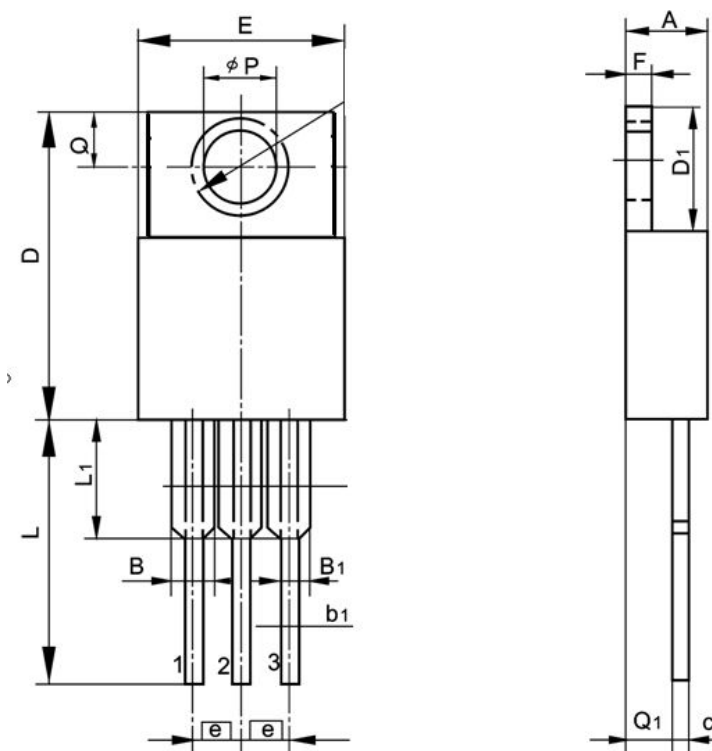

TO-220FP 封装机械尺寸 TO-220FP MECHANICAL DATA

单位:毫米/UNIT: mm

符号 SYMBOL	最小值 min	典型值 nom	最大值 max	符号 SYMBOL	最小值 min	典型值 nom	最大值 max
A	4.40		4.95	E	9.60		10.30
A ₁	2.30		2.90	e		2.54	
b	0.70		0.90	L	12.40		14.00
b ₁	1.18		1.45	L₂	2.30		2.60
c	0.40		0.70	L ₃	3.00		4.00
D	14.50		17.00	øp	3.00		3.50
D1	6.10		9.00	Q	2.30		2.80

