

N-沟道功率 MOS 管/ N-CHANNEL POWER MOSFET

SIFG19N060

- 特点：热阻低 导通电阻低 栅极电荷低，开关速度快 输入阻抗高 符合RoHS规范
- FEATURES: ■LOW THERMAL RESISTANCE ■LOW $R_{DS(ON)}$ TO MINIMIZE CONDUCTIVE LOSS ■LOW GATE CHARGE FOR FAST SWITCHING ■HIGH INPUT RESISTANCE ■RoHS COMPLIANT
- 应用：低压高频逆变电路 同步整流 开关应用
- APPLICATION: ■LOW VOLTAGE,HIGH FREQUENCY INVERTERS ■SYNCHRONOUS RECTIFIER ■PRIMARY SWITCH

●最大额定值 (TC=25°C)

●Absolute Maximum Ratings (Tc=25°C) SOP-8

参数 PARAMETER	符号 SYMBOL	额定值 VALUE	单位 UNIT
漏-源电压 Drain-source Voltage	V_{DS}	60	V
栅-源电压 gate-source Voltage	V_{GS}	± 20	V
漏极电流 Continuous Drain Current TC=25°C ①	I_D	19*	A
耗散功率 Total Power Dissipation ①	P_{tot}	3.1*	W
最高结温 Junction Temperature	T_j	150	°C
存储温度 Storage Temperature	T_{STG}	-55-175	°C
单脉冲雪崩能量 Single Pulse Avalanche Energy ②	E_{AS}	250	mJ

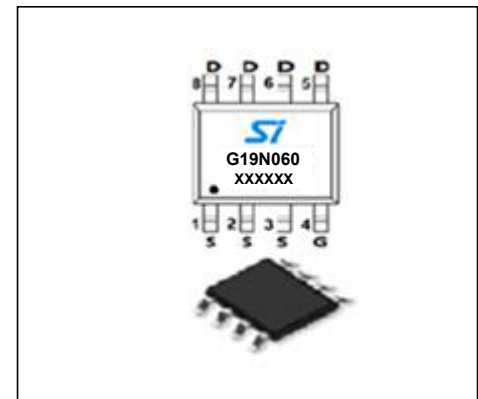
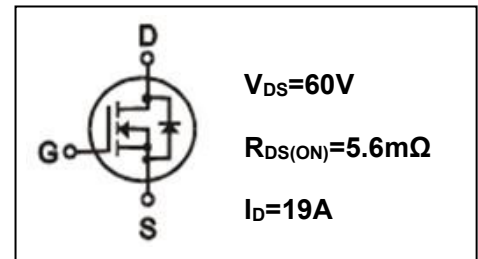

●电特性 (Tc=25°C)

●Electronic Characteristics (Tc=25°C)

参数 PARAMETER	符号 SYMBOL	测试条件 TEST CONDITION	最小值 MIN	典型值 TYP	最大值 MAX	单位 UNIT
漏-源击穿电压 Drain-source Breakdown Voltage	BV_{DSS}	$V_{GS}=0V, I_D=250\mu A$	60	74		V
栅极开启电压 Gate Threshold Voltage	$V_{GS(TH)}$	$V_{GS}=V_{DS}, I_D=250\mu A$	1.0	1.6	2.5	V
漏-源漏电流 Drain-source Leakage Current	I_{DSS}	$V_{DS}=60V, V_{GS}=0V, T_j=25^\circ C$			1	μA
		$V_{DS}=60V, V_{GS}=0V, T_j=125^\circ C$			10	μA
栅极漏电流 Gate-body Leakage Current	I_{GSS}	$V_{GS}=\pm 20V, V_{DS}=0V$			± 100	nA
漏-源导通电阻 Static Drain-source On Resistance	$R_{DS(ON)}$	$V_{GS}=10V, I_D=15A$		5.6	7.3	mΩ
		$V_{GS}=4.5V, I_D=10A$		7.7	10	
跨导 Forwad Transconductance	g_{FS}	$V_{DS}=5V, I_D=19A$		28		S

●订单信息/ORDERING INFORMATION:

包装形式/PACKING	订货编码/ORDERING CODE	
	普通塑封料/ Normal Package Material	无卤塑封料/Halogen Free
SOP-8 条管装/TUBE PACKING	SIFG19N060 SOP-8-TU	SIFG19N060 SOP-8-TU-HF
SOP-8 编带装/TAPE & REEL PACKING	SIFG19N060 SOP-8-TR	SIFG19N060 SOP-8-TR-HF

N-沟道功率MOS管/ N-CHANNEL POWER MOSFET

SIFG19N060

参数 PARAMETER	符号 SYMBOL	测试条件 TEST CONDITION	最小值 MIN	典型值 TYP	最大值 MAX	单位 UNIT
输入电容 Input Capacitance	Ciss	V _{GS} = 0V, V _{DS} = 25V F = 1.0MHZ		2900		pF
输出电容 Output Capacitance	Coss			1300		
反向传输电容 Reverse Transfer Capacitance	Crss			400		
栅极电荷 Total Gate Charge	Qg	I _D =19A, V _{DS} =30V V _{GS} = 10V		57.6		nC
栅源电荷 Gate-to-Source Charge	Qgs			7.0		nC
栅漏电荷 Gate-to-Drain Charge	Qgd			15.3		nC
栅极开启电荷量 Gate Charge At Threshold	Qg(th)			4.3		nC
导通延迟 Turn -On Delay Time	Td(on)	V _{DD} =30V, V _{GS} =10V, R _G =3Ω, R _L =1.6Ω		7.5		ns
开启上升时间 Turn -On Rise Time	T _r			6.5		ns
关断延迟 Turn -Off Delay Time	Td(off)			38		ns
关断下降时间 Turn -Off Fall Time	T _f			8		ns
二极管正向压降 Diode Forward Voltage	V _{SD}	T _j =25°C, I _F =1A V _{GS} =0V ③			1.3	V
反向恢复时间 Reverse Recovery Time	trr	I _f =19A, di/dt=500A/μs T _j =25°C, ③		22		ns
反向恢复电荷 Reverse Recovery Charge	Q _{rr}			80		nC

●热特性

●Thermal Characteristics

参数 PARAMETER	符号 SYMBOL	最大值 MAX	单位 UNIT
热阻结-壳 Thermal Resistance Junction-case	R _{thJA}	40	°C/W

注释(Notes):

- ① 以最高结温为限制， T_c=25°C时测试。
I_D & P_D base on maximum allowable junction temperature, test at T_c=25°C.
- ② 初始结温=25°C, V_{DD}=25V, V_{GS}=10V, L=0.5mH, V_{DS}=60V, R_g=25Ω, I_D=33A
Starting T_j=25°C, V_{DD}=25V, V_{GS}=10V, L=0.5mH, V_{DS}=60V, R_g=25Ω, I_D=33A
- ③ 脉冲测试: 脉冲宽度≤ 300μs , 占空比≤ 2%
Pulse Test : Pulse width ≤ 300μs, Duty cycle ≤ 2%

N-沟道功率 MOS 管/ N-CHANNEL POWER MOSFET

SIFG19N060

● 特性曲线



图 1 输出特性曲线

Fig.1 output characteristics

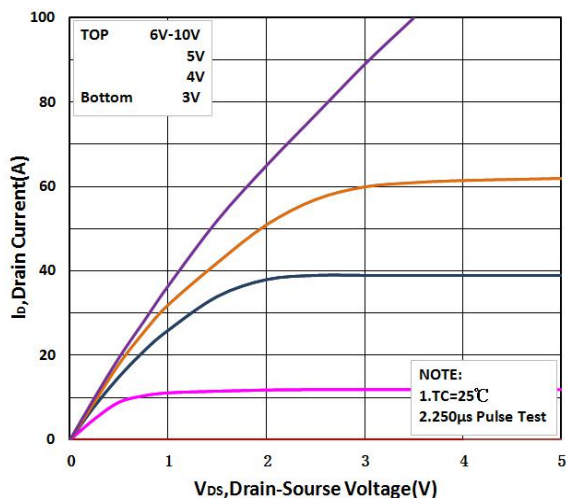

图 2 归一化导通电阻与结温关系曲线

Fig.2 Normalized RDSON vs. Tj

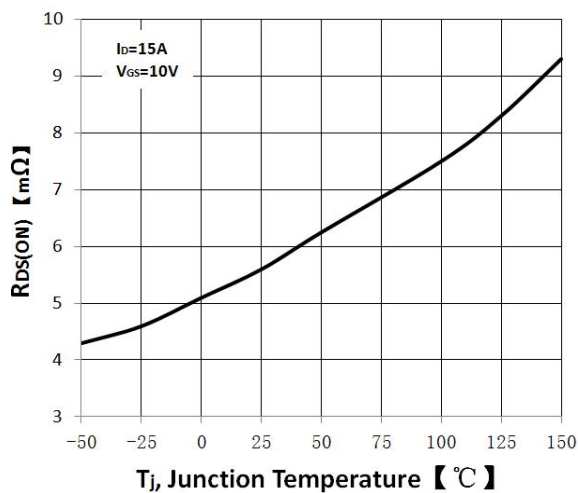

图 3 归一化开启电压与结温关系曲线

Fig.3 Normalized V_{th} vs. Tj

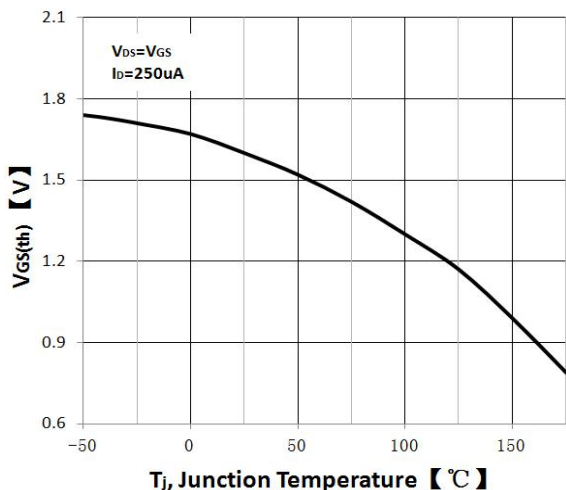

图 4 栅电荷波形

Fig.4 Gate Charge Waveform

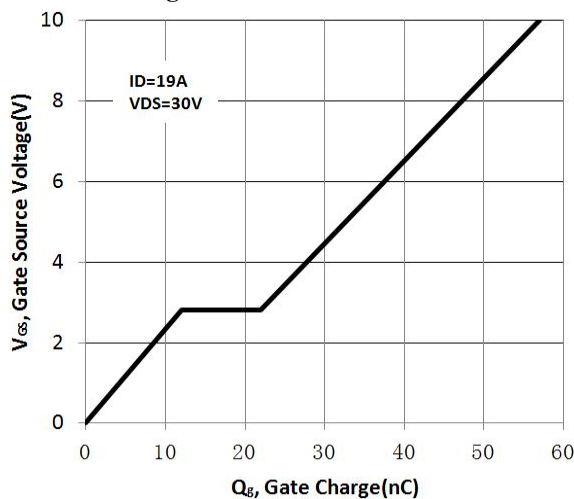

图 5 电容曲线

Fig.5 Capacitance

SOP8 封装机械尺寸 SOP8 MECHANICAL DATA

单位:毫米/UNIT: mm

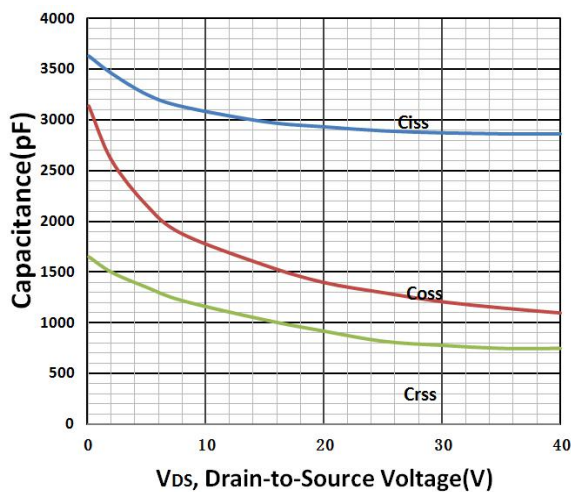
符号 SYMBOL	最小值 min	典型值 nom	最大值 max	符号 SYMBOL	最小值 min	典型值 nom	最大值 max
A	4.80		5.10	C	1.30		1.50
A1	0.37		0.47	C1	0.55		0.75
A2		1.27 TYP		C2	0.55		0.65
A3		0.41 TYP		C3	0.05		0.20
B	5.80		6.20	C4	0.19	0.20TYP	0.23
B1	3.80		4.00	D		1.05TYP	
B2		5.0TYP		D1	0.40		0.62

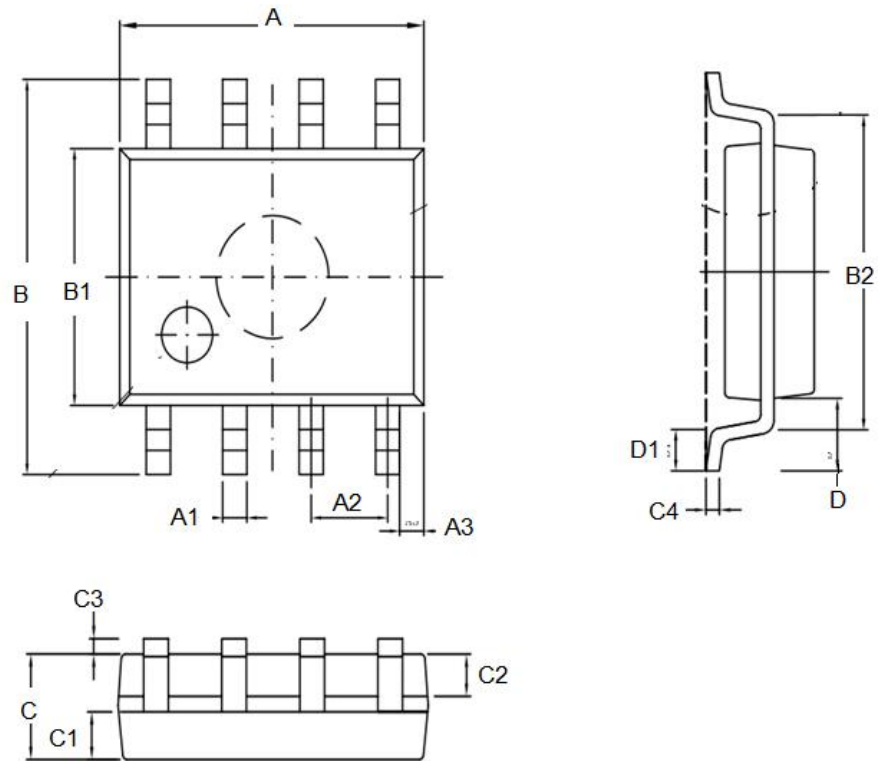

SOP8 (13")编带规格 SOP8 (13")TAPE AND REEL DATA

单位:毫米/UNIT: mm

